

5 Die Platonischen Körper in computergrafischen Bilderbögen



Abb. 5.1.1- 5

... in ihren Größenverhältnissen

**Abb. 5.2.1- 5****... in besonderer parallelprojektiver Sicht**

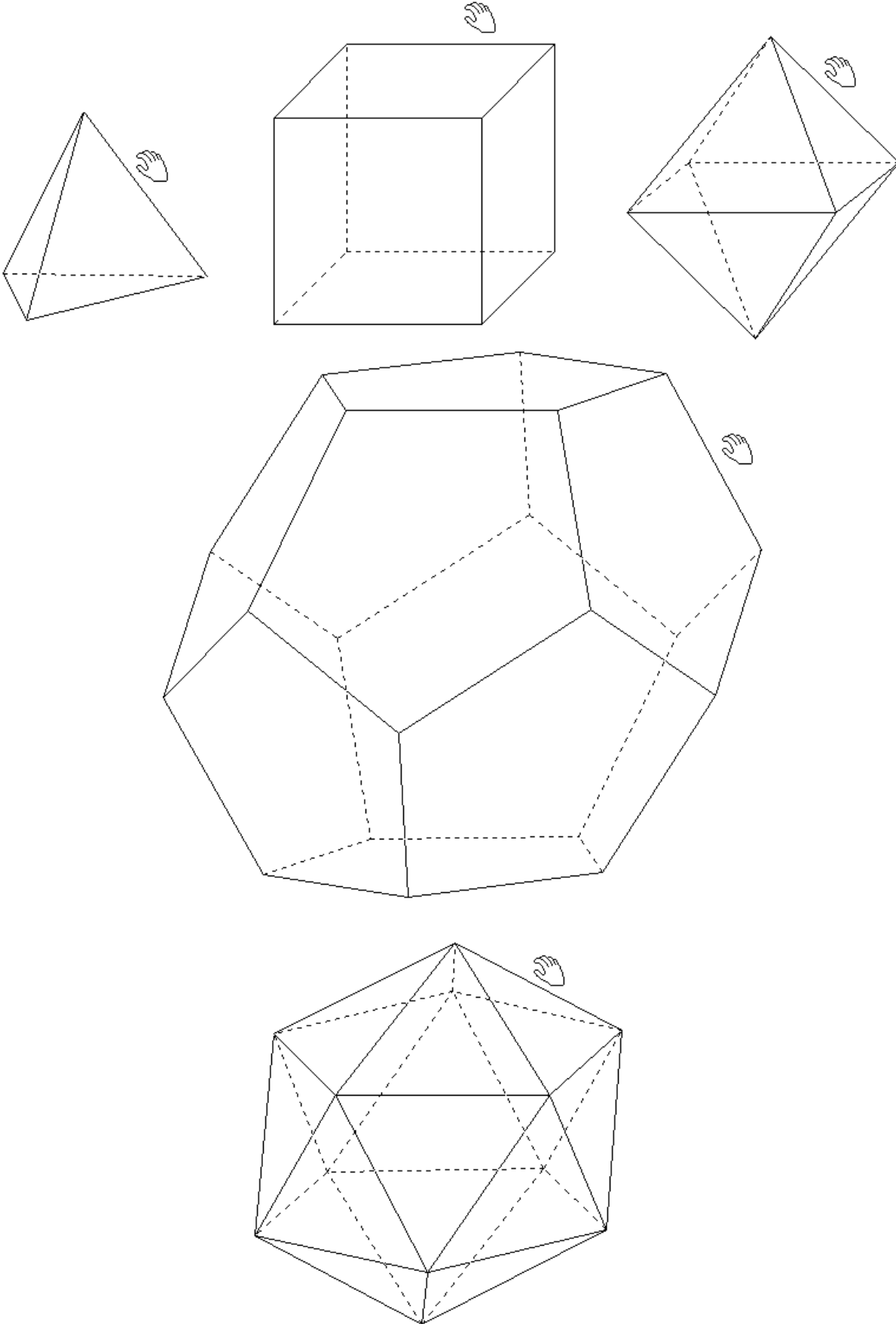
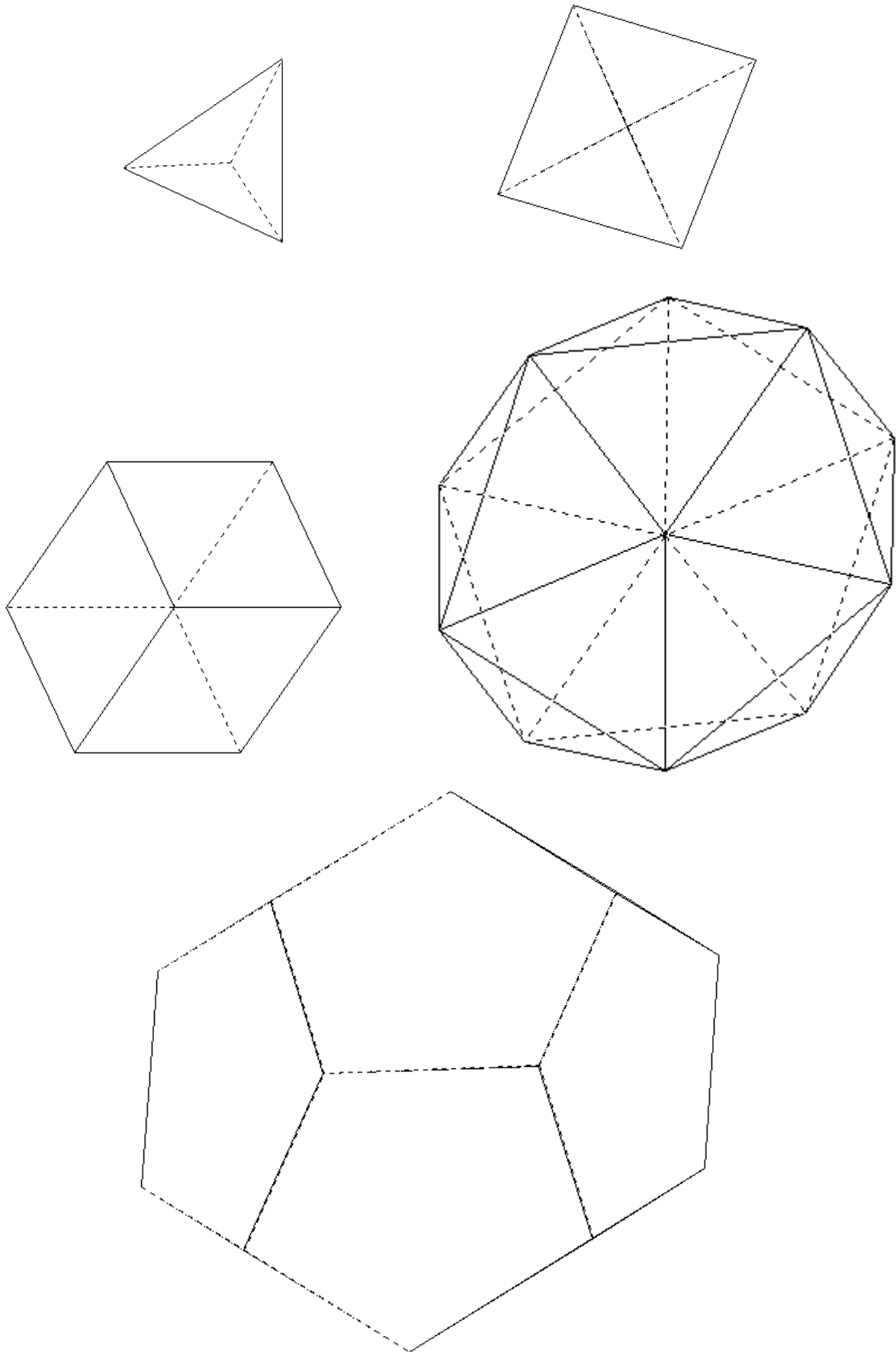

Abb. 5.3.1- 5

... zentralprojektiv und beleuchtet

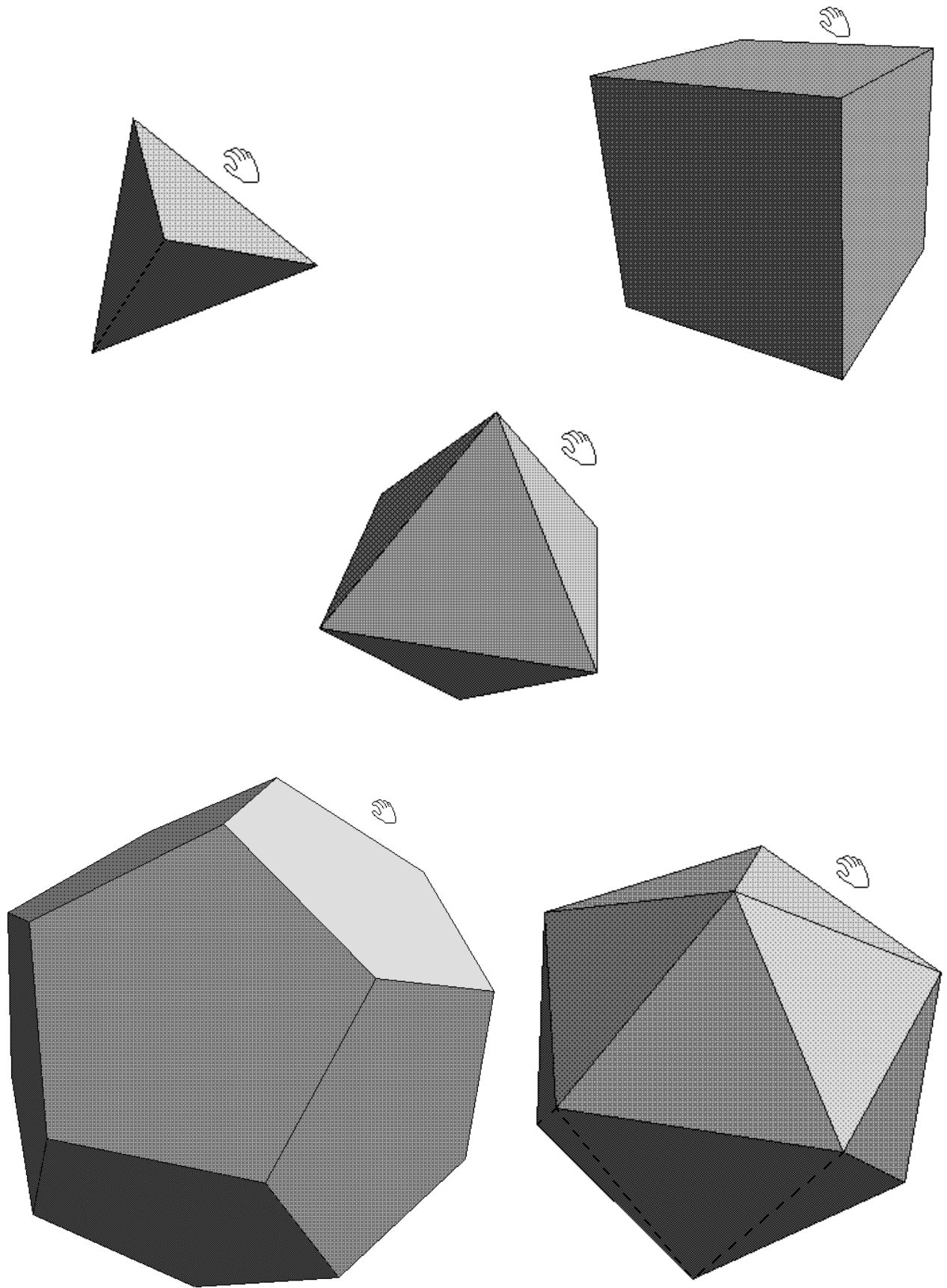

Abb. 5.4.1- 5

... mit besonderen Netzen

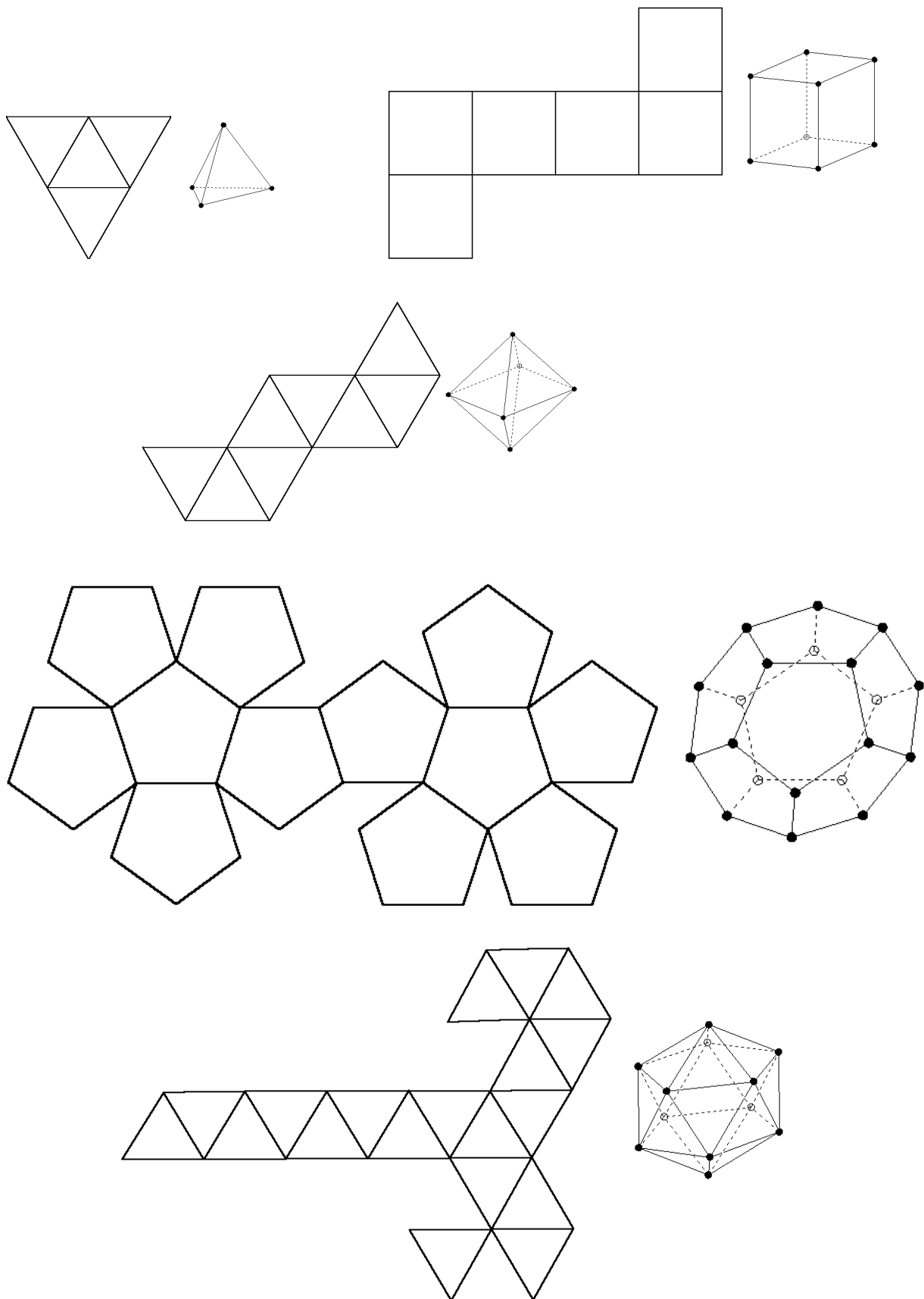

Abb. 5.5.1- 4

... mit Mittelpunktslinien und -flächen

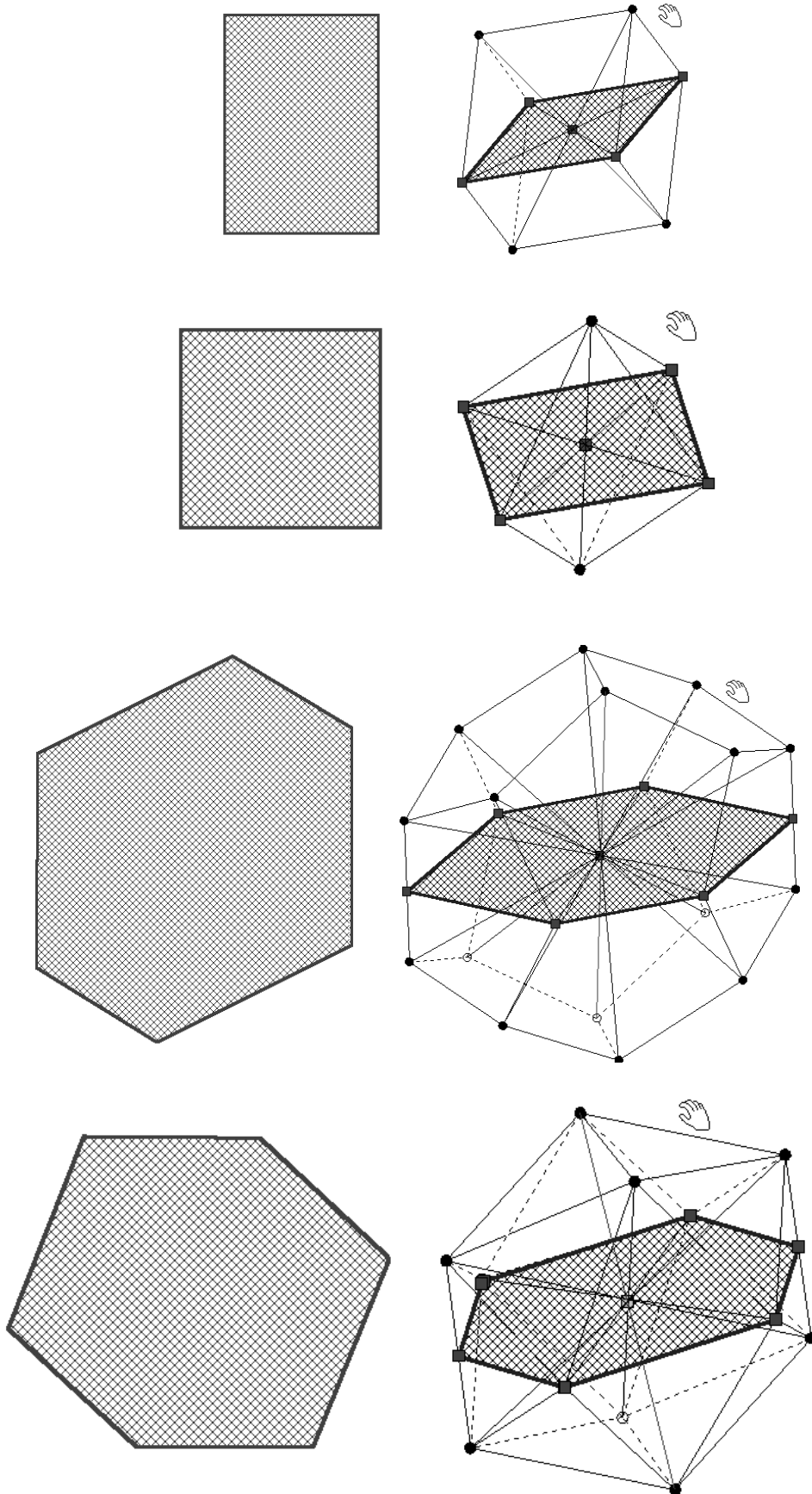

Abb. 5.6.1- 4

Vom Würfel zum Tetraeder

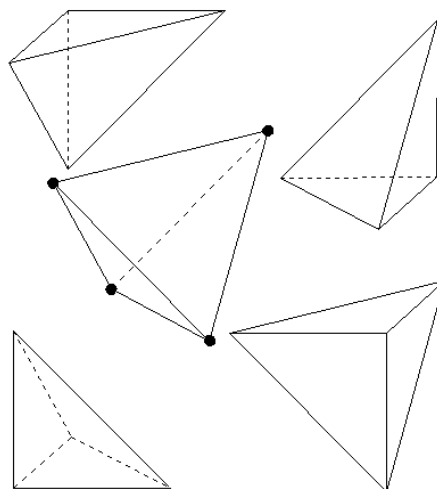
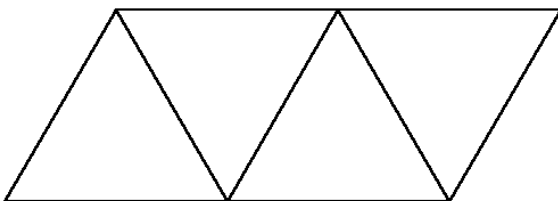
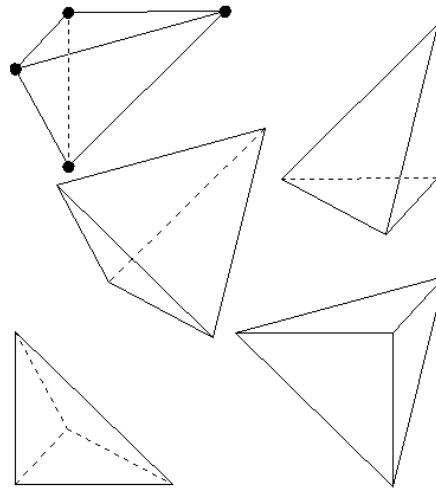
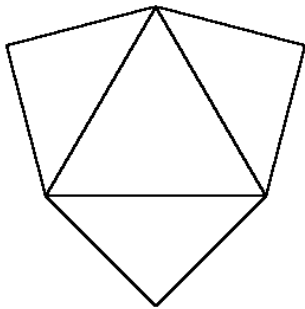
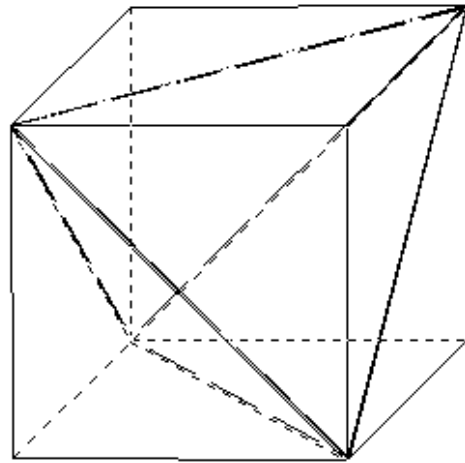
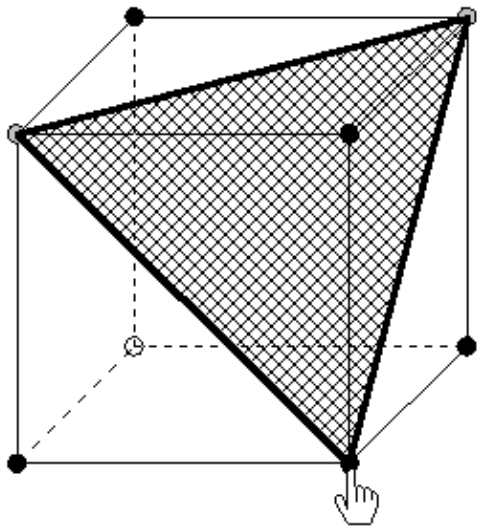

Abb. 5.7.1- 4

Vom Oktaeder zum Würfel

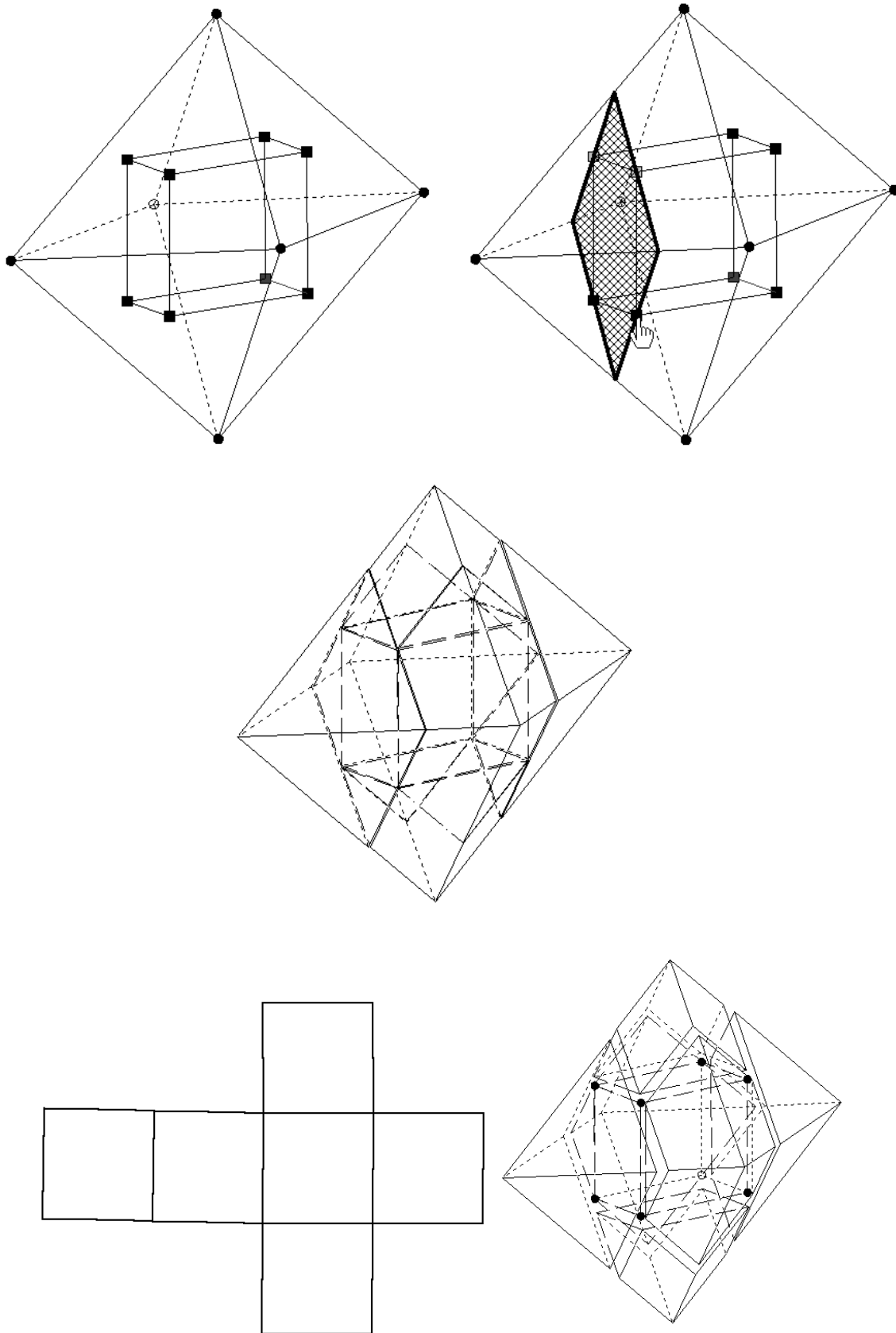

Abb. 5.8.1- 4

Bestandteile des Dodekaeders

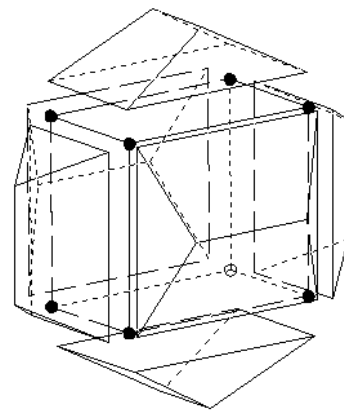
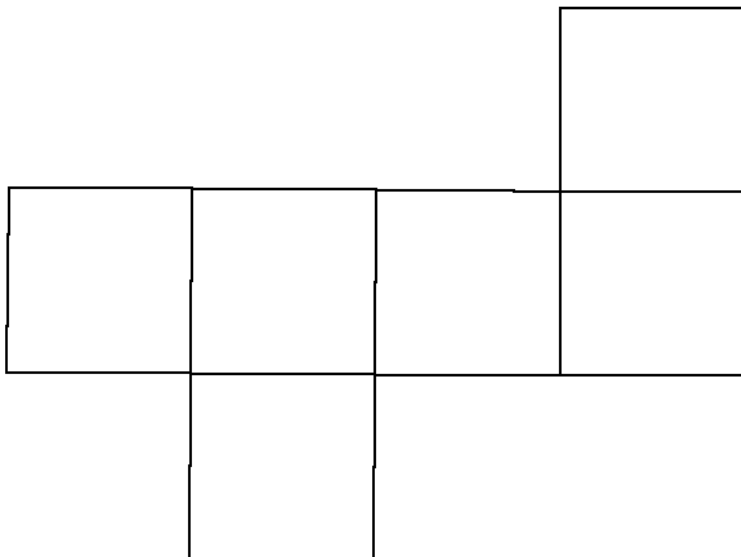
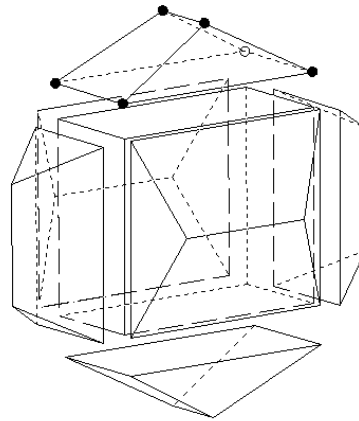
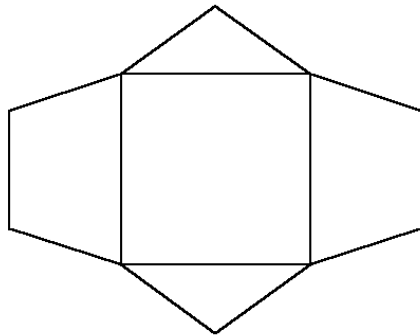
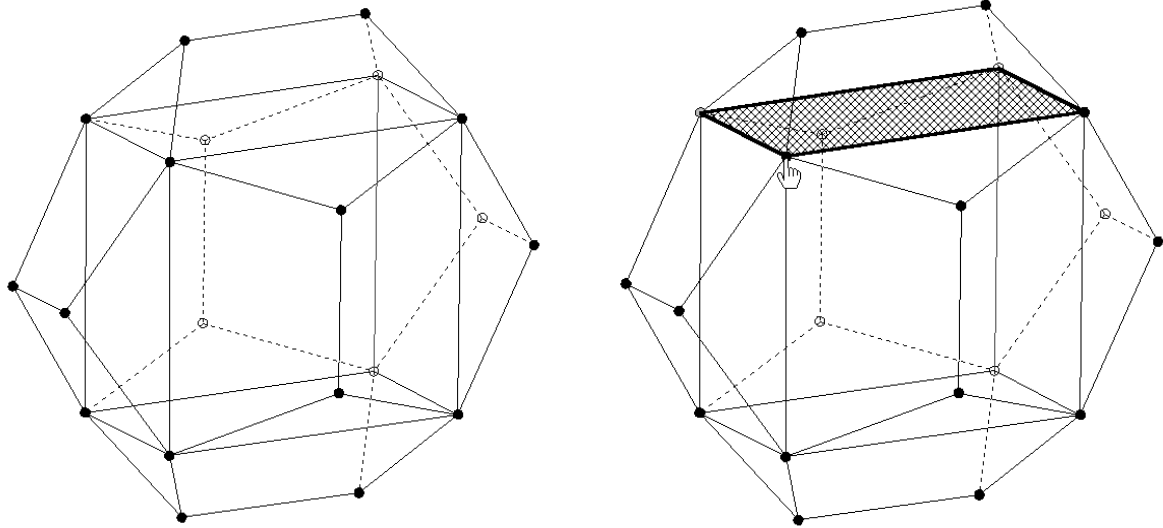

Abb. 5.9.1- 4

Bestandteile des Icosaeders

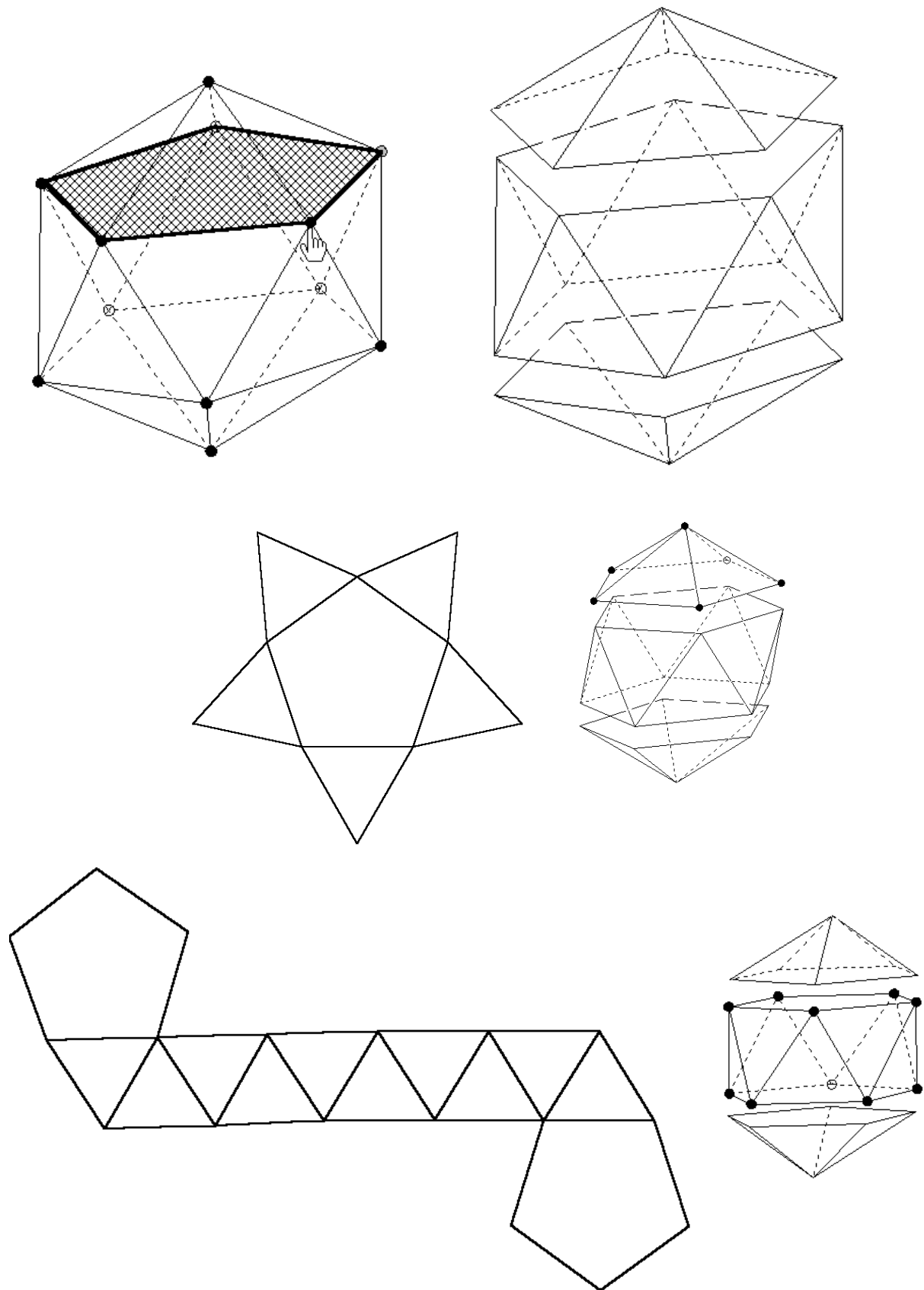

Abb. 5.10.1- 6

Besondere gesternte oder gezeltete Iksaeder

Schumann: Platonische Körper (Bilderbögen)

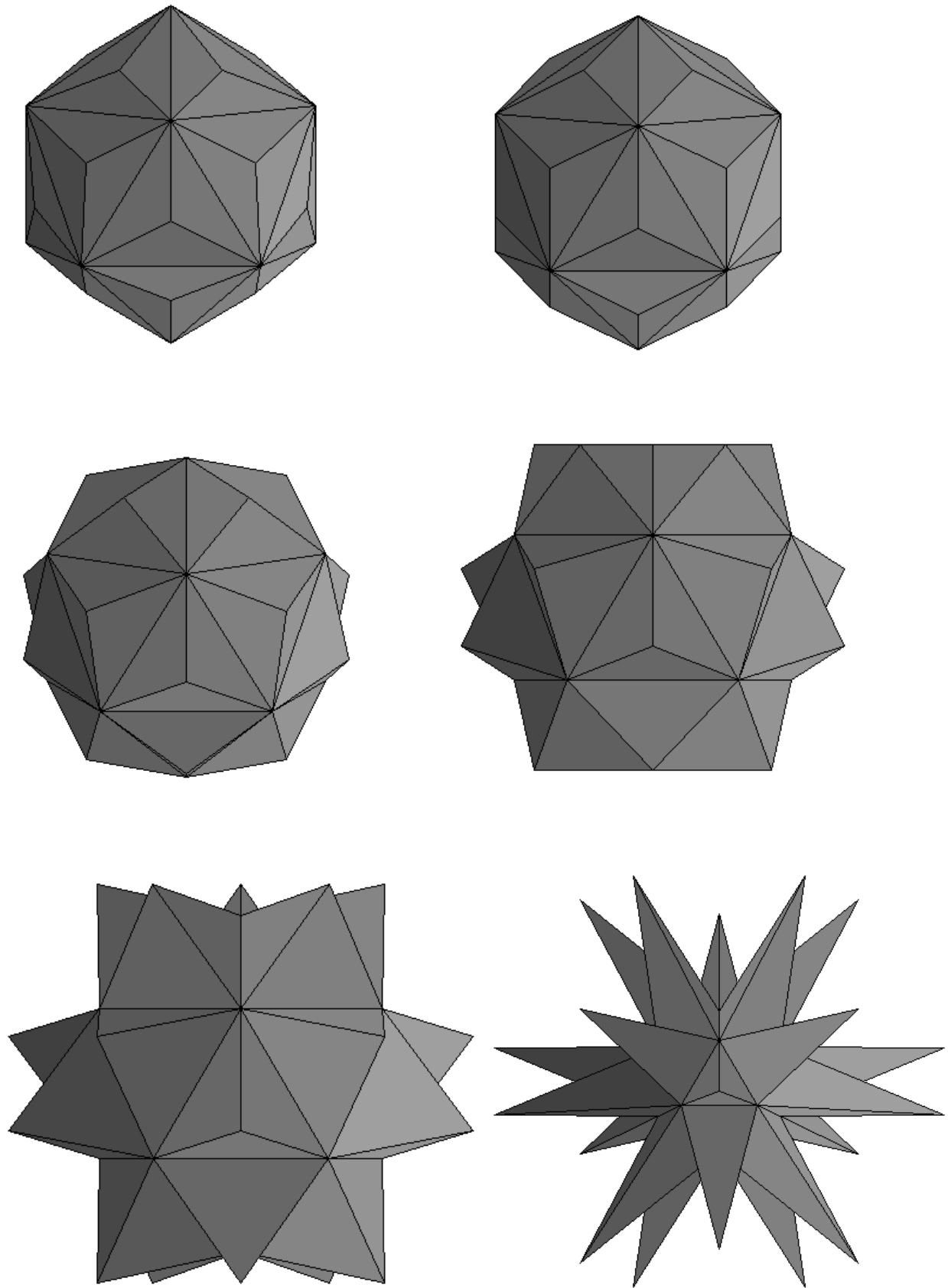